

The logo for SANKŌSHA, featuring a stylized blue 'S' symbol followed by the company name in a bold, black, sans-serif font.

Catalog for Lightning Protection

Power Supply SPD, SPD for Communication Equipment,
SPD for Co-axial Connectors, SPD for LAN, Earthing SPD,
Earth Grounding Materials.

A large, stylized letter 'S' in a light blue color, filled with a white lightning bolt pattern. It is positioned on the left side of the cover.

urge

A large, stylized letter 'P' in a light blue color, filled with a white pattern of concentric circles. It is positioned in the middle of the cover.

rotective

A large, stylized letter 'D' in a light blue color, filled with a white circuit board pattern. It is positioned on the right side of the cover.

evice

What's SPD?

SPD stands for Surge Protective Device. SPDs protect electrical equipment and electronic devices from lightning damage by limiting the lightning surge (transitional overvoltage and current) caused by lightning strikes.

Lightning damage is caused by direct lightning and indirect lightning.

Direct lightning is a phenomenon whereby facilities or objects on the ground are directly struck by lightning. Because a huge lightning current flows in and results in an explosive discharge after being instantaneously converted into not only electrical energy but also thermal and mechanical energy, this imparts damage to various equipment and devices.

Indirect lightning refers to lightning that is induced along power lines or communication lines. Induced lightning infiltrates through power lines, communication lines, grounding lines and the like. Almost all cases of lightning damage are caused by this type of indirect lightning.

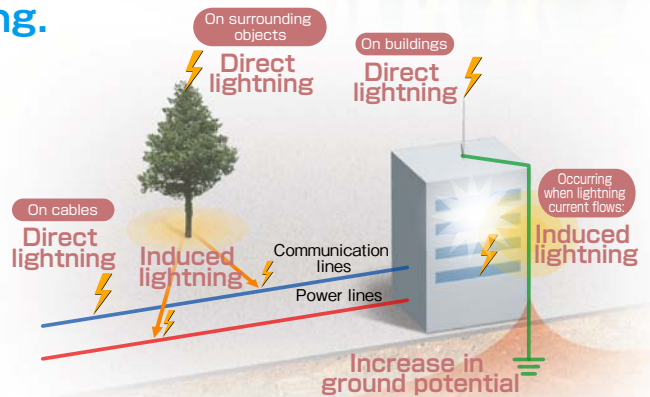

Damage caused by lightning happens in familiar situations.

In recent years, there have been numerous cases of damage caused by sudden lightning strikes. In particular, lightning surges flowing through power lines and communication lines have imparted massive negative impacts on connected devices.

Damage Case 1 Failure of office PCs and server equipment

A lightning strike occurring close to an office building caused a lightning surge to flow along power lines and communication lines, resulting in damage to circuit boards inside PCs and telecommunications devices. The resulting loss of stored data had a major impact on work operations.



Circuit boards damaged by a lightning surge

Damage Case 2 Occurrence of error during test measurement!

A lightning strike occurring inside facilities damaged devices that were undergoing measurement.

Generally speaking, some integrated circuits and electronic components that comprise electronic devices have low impulse withstand voltage and are very vulnerable to lightning surges.

* Impulse withstand voltage = Value of momentary overvoltage that a device can withstand



Integrated circuit and resistor damaged by lightning surge

Damage Case 3 Interruption of power supply to a production line!

A lightning strike occurring inside plant facilities caused damage to the power receiving panel. This led to interruption of the power supply, making it impossible for the plant to continue production.

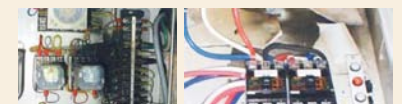

Power receiving panel damaged by lightning surge

It is important to prevent the infiltration of lightning surges through installing suitable SPDs.

By installing SPDs that are suitable to power lines and communication lines, which become infiltration routes for lightning surges, it is possible to protect precious devices and data from lightning damage. The following pages introduce basic know-how and outlines concerning SPD selection.

Power Supply SPD



SPD for Communication Equipment



SPD for Co-axial Connectors



SPD for LAN

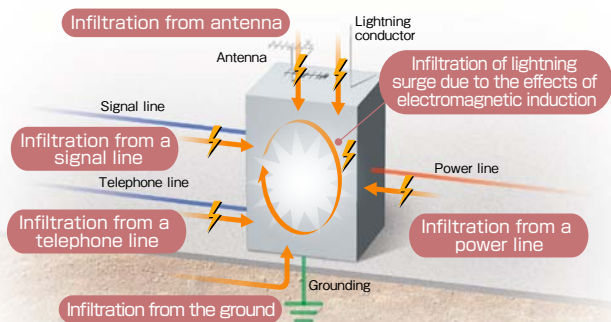

Lightning Protection-related IEC

The IEC 62305 series is a set of standards related to lightning protection measures. There is also the IEC 61643 series. These standards pertain to SPDs and lightning protection elements. The following table lists the representative JIS standards that pertain to lightning protection.

Standard	Name of standard
IEC 60364-4-43:2023	Low-voltage electrical installations – Part 4-43: Protection for safety – Protection against overcurrent
IEC 62305-1:2010	Protection against lightning – Part 1: General principles
IEC 62305-3:2010	Protection against lightning – Part 3: Physical damage to structures and life hazard
IEC 62305-4:2010	Protection against lightning – Part 4: Electrical and electronic systems within structures
IEC 61643-11:2011	Low-voltage surge protective devices – Part 11: Surge protective devices connected to low-voltage power systems – Requirements and test methods
IEC 61643-12:2020	Low-voltage surge protective devices – Part 12: Surge protective devices connected to low-voltage power systems – Selection and application principles
IEC 61643-21:2012	Low voltage surge protective devices – Part 21: Surge protective devices connected to telecommunications and signalling networks – Performance requirements and testing methods
IEC 61643-22:2015	Low-voltage surge protective devices - Part 22: Surge protective devices connected to telecommunications and signalling networks - Selection and application principles

1. Direct Lightning and Induced Lightning Current Waveforms

In the IEC 61643 series, the current waveforms of test impulses are simulated as 10/350 μ s for direct lightning and 8/20 μ s for induced lightning. Because lightning energy corresponds to the time integral of direct lightning, it can be seen that direct lightning is much more powerful than induced lightning.

- = Direct lightning 10/350 μ s
•50kA waveform (Class I Category D)
- = Induced lightning 8/20 μ s
•50kA waveform (Class II Category C)

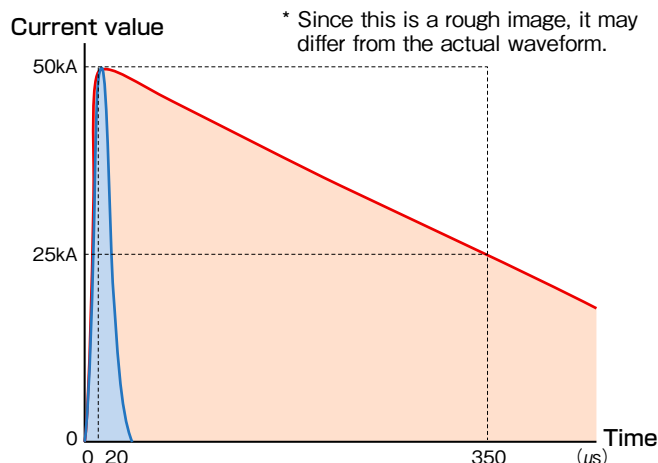

2. Lightning Protection Zone

In the IEC 62305 series, the Lightning Protection Zone (LPZ) refers to zoning of the space in which protected electrical and/or electronic devices are installed in order to protect devices from the impact of the lightning electromagnetic impulse based on degree of impact. (LEMP). Zones are classified as shown below.

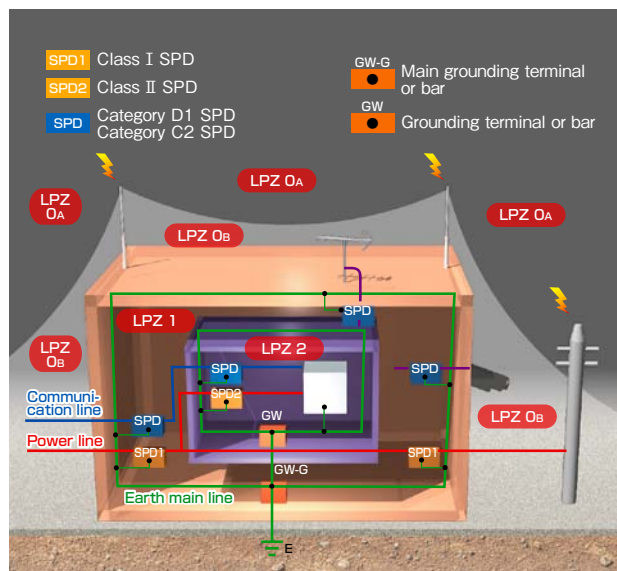

Lightning Protection Zone (LPZ)		LPZ and SPD Class and Category		
External zones	LPZ 0	In this zone, the electromagnetic field caused by direct lightning is not reduced, and equipment is exposed to the threat of full or partial lightning current. This zone is divided into the following two types.		
	LPZ 0 _A	Boundary between LPZ0 _A / LPZ0 _B and LPZ 1	Class I, II Category C2, D1	
	LPZ 0 _B			Situated outside of the scope of LPS protection, this zone is exposed to the threat of full lightning current arising from the electromagnetic field caused by direct lightning and lightning, and equipment is exposed to the threat of full lightning current. The electromagnetic field occurring here does not attenuate.
Internal zones	LPZ 1	Boundary between LPZ 1 and LPZ 2-N	Class II Category C2	
	LPZ 2			This zone is protected against direct lightning. The surge current is reduced compared to LPZ0 _B thanks to installation of SPD on the zone perimeter, and it is possible to reduce the electromagnetic field by means of magnetic shielding formed on the perimeter.
	LPZ 2-N			This is the later attenuation zone (LPZ 2 and beyond), where current and electromagnetic field can be further reduced by additional SPD installation and magnetic shielding.

3. Shunting of Lightning Current

Concerning the shunting of direct lightning strikes on buildings, in IEC 61643-12: 2020 and IEC62305-4: 2010, in cases where it is impossible to perform individual calculation based on the grounding resistance value and cable impedance, it is stipulated that 50% of the total current flows to ① the grounding electrode, and the remaining 50% flows through an SPD to ② an external supply line (power line, communication line, etc.).

Moreover, the current value (I_i) that flows to each supply line, assuming the current value flowing to the external supply lines to be (I_s) and the number of supply lines to be n , is calculated as $I_i = I_s/n$.

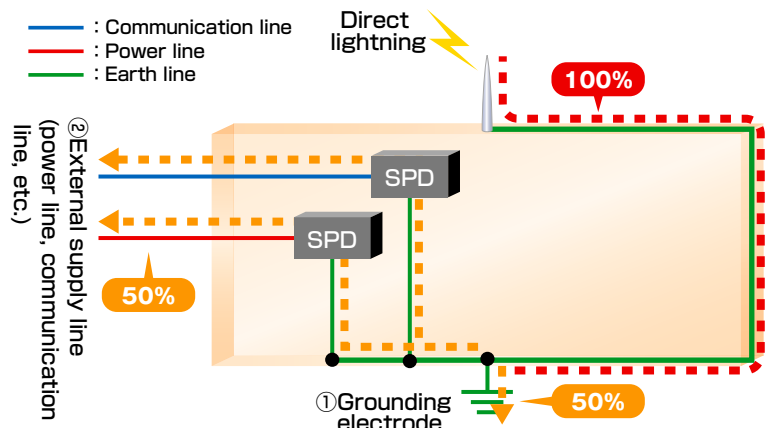

4. Lightning Protection Level (LPL)

In IEC 62305-1: 2010, the Lightning Protection Level (LPL) is divided into four levels, i.e. LPL I to IV, according to the lightning current wave crest value of direct lightning. The table on the right summarizes the maximum current values passing through the SPD that are forecast based on the current wave crest value in each level and the above thinking (shunting of lightning current). Incidentally, this maximum current value assumes there is one external supply line ($n = 1$).

For example, in the case where only a power line (single-phase two-wire, 100V) is connected to a building and direct lightning of 100kA occurs, the current will be $I_i = 50/2 = 25kA$.

Protection Level	Protection Effect	Lightning Current Wave Crest Value (10/350 μ s)	Maximum Current Going to SPD (10/350 μ s)
I	98%	200kA	100kA
II	95%	150kA	75kA
III	90%	100kA	50kA
IV	80%	100kA	50kA

5. Impulse Withstand Voltage Value

Although the commercial frequency withstand voltage values of electrical and electronic devices are publicly disclosed, this is not always the case regarding impulse withstand voltage.

In such cases, because the impulse withstand voltage value of devices connected to a low-voltage power circuit is stipulated in IEC 60364-4-43: 2023, this can be referred to in selecting the power supply SPD.

Concerning selection of the communication SPD, since the impulse withstand voltage value is not stipulated in any standards, detailed information (electrical specifications, component elements, etc.) is required to make the selection.

Equipment Nominal Voltage		Required Impulse Withstand Voltage			
Category		Category IV	Category III	Category II	Category I
Type		Equipment lead-in device	Main line and branch circuit	Load device	Specially protected device
Single-phase three-wire	120-240	4kV	2.5kV	1.5kV	0.8kV
	230/400 277/480	6kV	4kV	2.5kV	1.5kV
Three-phase system	400/690	8kV	6kV	4kV	2.5kV
	Applications	Watt-hour meters, Current limiters, Earth leakage circuit breakers	Distribution boards, Distribution circuit breakers, Sockets	Telephones, fax machines, PCs, Communications devices, Lighting equipment	Interiors of devices

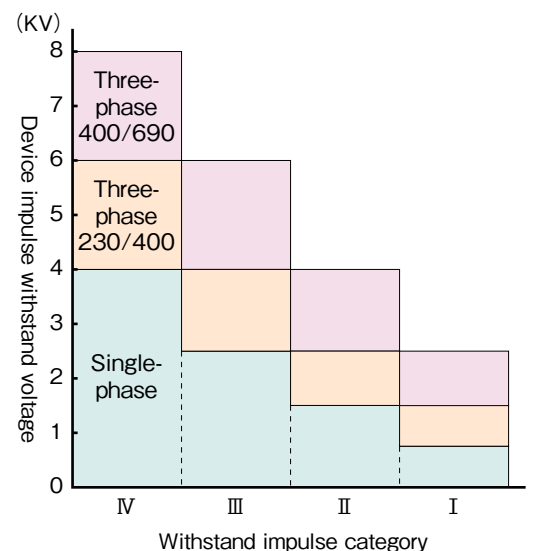

Method for Selecting SPDs Considering Impulse Withstand Voltage

To protect electrical and electronic devices from lightning surges, it is necessary to select the SPD to ensure that the voltage value suppressed by the SPD (voltage protection level) does not exceed the voltage value that devices can transitionally withstand (impulse withstand voltage value).

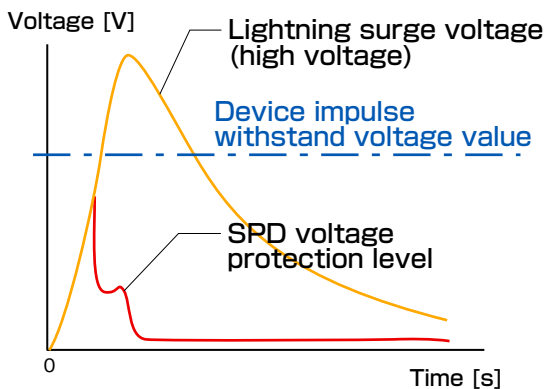

Voltage no higher than the withstand voltage

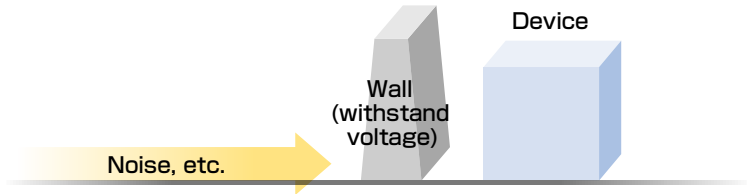

Abnormal voltage higher than the withstand voltage



Role of SPDs

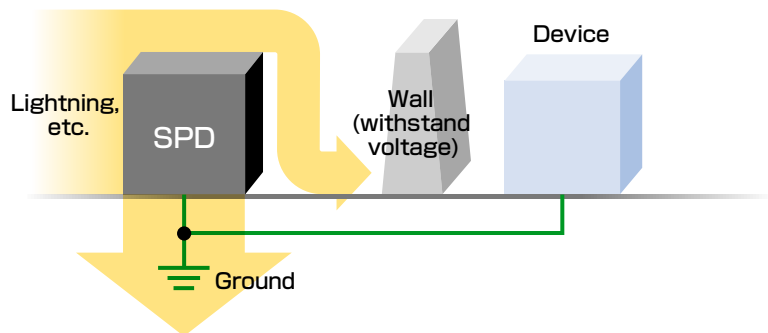

Select your ideal SPD from SANKOSHA's abundant lineup of products.

SANKOSHA has deployed solutions centered on lightning protection for 90 years. Underpinned by a wealth of experience and solid technical capability, we have an abundant lineup of SPDs that are sure to provide optimum lightning protection in response to customers' needs.

Advanced Smart SPD® Series with Smart Features

The Smart SPD® Series is equipped with smart display features in addition to conventional SPD performance. These features clarify the SPD lightning protection effect and make it possible to improve maintenance efficiency.



Features

Visualizing the protection effect

The SPD counts the number of lightning surges and notifies the number of times that devices have been protected from lightning.

Display of recommended replacement timing

The SPD notifies the replacement timing before deterioration occurs, thereby realizing smart lightning protection.

Lightning Current (Lightning Surge) Infiltration and Outflow Routes

The following indicates the infiltration and outflow routes taken by induced lightning surges and the damage caused to electrical and electronic devices, etc. when buildings (direct lightning) or outdoor distribution lines are struck by lightning.

Mechanism of equipment destruction by direct lightning

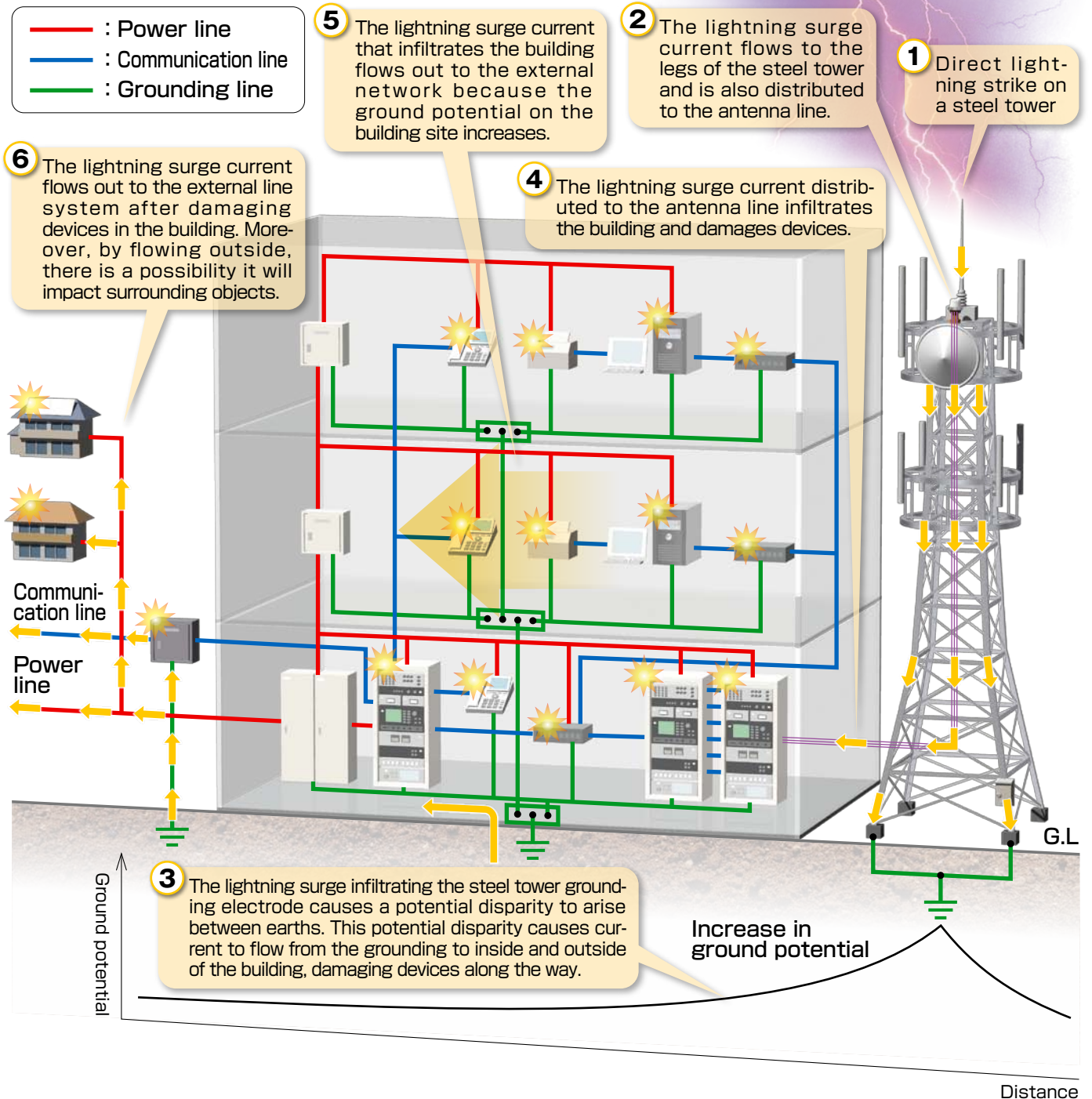

Power Supply SPD



MZS-200AV
P.7



MZS-NPE
P.7



SMBP-MZSR
P.9

SPD for Communication Equipment



SMH-CLP
P.11



ZP
P.12



HOWL2 SMB-P-R
P.13

Example of Lightning Countermeasures through SPD Installation

SPD installation minimizes the damage caused by the lightning surge which infiltrates the building.

- S** : Power supply SPD
- S** : SPD for communication equipment
- S** : SPD for co-axial connectors
- S** : SPD for LAN
- S** : Earthing SPD

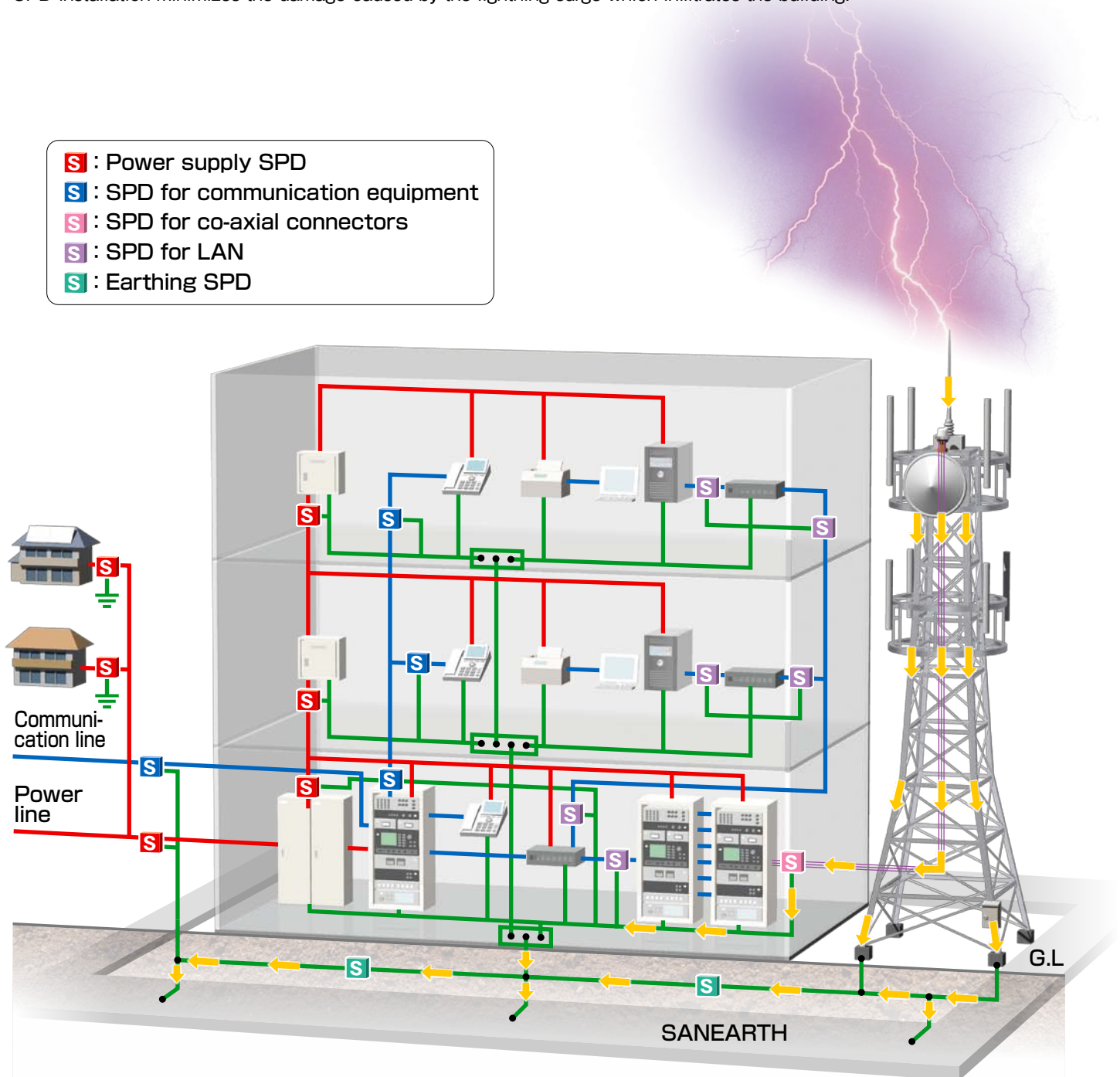

The lower the grounding resistance value the better.

SPD for Co-axial Connectors



CX-E-60(R)
P.15



N-JP-8
P.16

SPD for LAN



LAN-CAT6A-P+II(R)
P.17



LAN-CAT6A-IS
P.17

Earthing SPD



MZS-EB
P.18

Earthing



SAN-EARTH
P.18

Power Supply SPD IEC Class I (Type 1) Direct Lightning Countermeasures

By installing it on the boundary between LPZO and LPZ1, this SPD has the ability to protect from direct lightning.

Class	Recommended connection line cross-sectional area (Protected device-SPD L terminal)	Recommended grounding line cross-sectional area (SPD terminal- Protected device)
I	8~14mm ²	14~22mm ²

IEC 62305-4:2010

MZS-200AV

IEC Class I/II compliant

Conforming standards

- IEC 61643-11 compliant
- IEC 62305 compliant
- CE marking
- RoHS compliant
- KEMA compliant

Features

- Impulse sparkover current up to 25 kA (direct strike waveform 10/350 μs)
- Voltage protection level 2.0kV or less
- High follow current shutoff ability
- Deterioration display function (warning contact output terminal attached)
- DIN rail mountable (35 mm)

Applications

- Low voltage power supply circuits in switchboards and distribution boards (AC100V-240V,230/400V)
- Power supply circuits in control equipment (AC100V-240V,230/400V)



MZS-200AV
Dimensions: W35×D125×H66 (mm)
Mass: 370 (g)

Characteristics

Item	Measurement conditions	Performance
Item code	—	1111015650
Maximum continuous operating voltage (50/60Hz) (Uc)	—	275V
Impulse current (Iimp)	10/350μs	25kA
Nominal discharge current (In)	8/20μs	25kA
Voltage protection level (Up)	Based on IEC	1.5 kV or less

External view

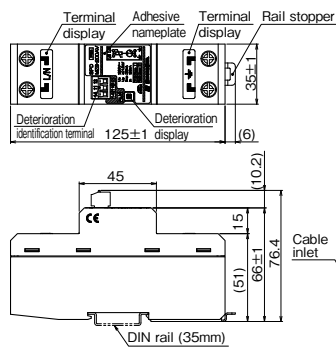

Circuit diagram

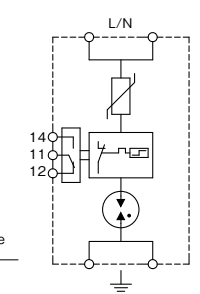

MZS-NPE

IEC Class I/II compliant

Conforming standards

- IEC 61643-11 compliant
- IEC 62305 compliant
- CE marking
- RoHS compliant
- KEMA compliant

Features

- Impulse sparkover current up to 75 kA (direct strike waveform 10/350 μs)
- Voltage protection level 1.5 kV or less
- DIN rail mountable (35 mm)

Applications

- Low voltage power supply circuits in switchboards and distribution boards (AC100V-240V,230/400V)
- Power supply circuits in control equipment (AC100V-240V,230/400V)



MZS-NPE
Dimensions: W35×D125×H66 (mm)
Mass: 290 (g)

Characteristics

Item	Measurement conditions	Performance
Item code	—	1111017380
Maximum continuous operating voltage (50/60Hz) (Uc)	—	255V
Impulse current (Iimp)	10/350μs	100kA
Nominal discharge current (In)	8/20μs	100kA
Voltage protection level (Up)	Based on IEC	1.5 kV or less

External view

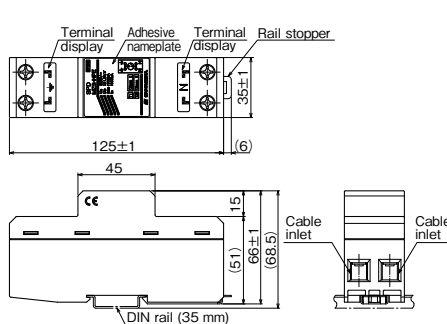

Circuit diagram

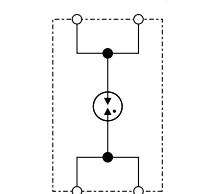

Power supply SPD Class I MZS, MZG fuse

SPD external separator, IEC Class I fuse

Features

- DIN rail mountable (35 mm)
- Use in combinations of single core units is possible.

Applications

- SPD external separator fuse and holder used in combination with SPDs suitable for power supply SPD Class I testing
- If the SPD is damaged by shorting, it can be blocked from the power network.

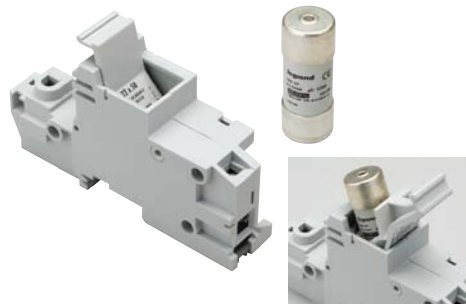

Dimensions: W36×D140×H87 (mm) (When the clip is closed)
Mass: 250 (g)

Characteristics

Item	Performance
Fuse main unit item code	1111012972
Fuse holder item code	1111012973
Rated voltage	AC400V
Rated current	125A
Rated breaking capacity	100kA

Power Supply SPD IEC Class II (Type 2) Induced Lightning Countermeasures

By installing it on the boundary between LPZ1 and LPZ2, this SPD has the ability to protect from induced lightning.

Class	Recommended connection line cross-sectional area (Protected device-SPD L terminal)	Recommended grounding line cross-sectional area (SPD terminal- Protected device)
II	3.5~5.5mm ²	5.5~8mm ²

IEC 62305-4:2010

Smart SPD® SMBP-MZSR200 series SMBP-MZSR400 series

IEC Class II compliant

Conforming standards

- IEC 61643-11 compliant
- IEC62305 compliant
- RoHS compliant

Features

- Maximum discharge current up to 40kA (induction lightning waveform 8/20μs)
- Lightning surge current measurement, Replacement recommendation display function
- Lightning surge current count display function
- Plug-in type
- Deterioration display function (warning contact output terminal)
- DIN rail mountable (35mm)

Applications

- Low voltage power supply circuits in switchboards and distribution boards (AC100V-240V,400V,230/400V,277/480V)
- Power supply circuits in control equipment (AC100V-240V,400V,230/400V,277/480V)

Product type identification

SMBP - MZSR JK

Maximum continuous operating voltage (Uc)
200 : AC275V
400 : AC500V

-None: No gap
-AR: With gap (N-PE)

1~3: SPD connectivity number



Smart SPD®
SMBP-MZSR
200JK2



Smart SPD®
SMBP-MZSR
400JK3AR

(SMBP-MZSR400JK3AR)
Dimensions: W72×D99×H81 (mm)
Mass: 410 (g)

Characteristics

Item	Measurement conditions	Performance											
		SMBP-MZSR 200JK1	SMBP-MZSR 200JK2	SMBP-MZSR 200JK3	SMBP-MZSR 200JK1 AR	SMBP-MZSR 200JK2 AR	SMBP-MZSR 200JK3 AR	SMBP-MZSR 400JK1	SMBP-MZSR 400JK2	SMBP-MZSR 400JK3	SMBP-MZSR 400JK1 AR	SMBP-MZSR 400JK2 AR	SMBP-MZSR 400JK3 AR
Item code	—	11110 42023	11110 42024	11110 42025	11110 42026	11110 42027	11110 42028	11110 42069	11110 42070	11110 42071	11110 42072	11110 42073	11110 42074
Maximum continuous operating voltage (50Hz/60Hz) (Uc)	—	AC275V						AC500V					
Maximum discharge current (Imax)	8/20μs	40kA											
Nominal discharge current (In)	8/20μs	20kA											
Voltage protection level (Up)	Based on IEC	1.4kV or less (each phase)			1.4kV or less (each phase) 1.5kV or less (N-PE)			2.5kV or less (each phase)			2.5kV or less (each phase) 1.5kV or less (N-PE)		

External view (SMBP-MZSR200JK2)

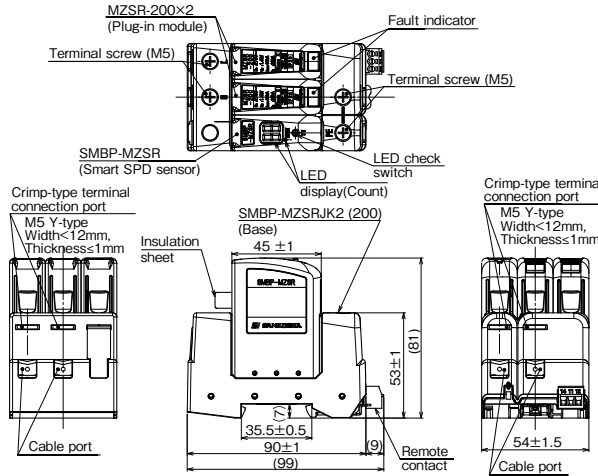

Display

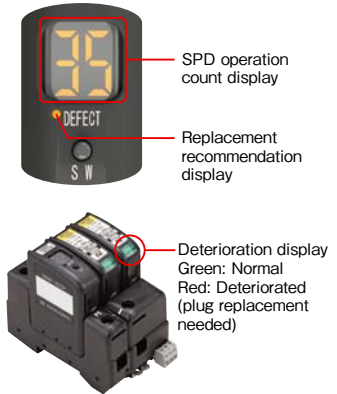

MZSR-200 series MZSR-400 series

IEC Class II compliant

Conforming standards

- IEC 61643-11 compliant
- UL standard acquired (E328370)
*MZSR-200JK []
- RoHS compliant

Features

- Maximum discharge current up to 40kA (induction lightning waveform 8/20μs)
- Plug-in type
- Deterioration display function (warning contact output terminal)
- DIN rail mountable (35mm)

Applications

- Low voltage power supply circuits in switchboards and distribution boards (AC100V-240V,400V,230/400V,277/480V)
- Power supply circuits in control equipment (AC100V-240V,400V,230/400V,277/480V)



MZSR-200JK2



MZSR-400JK3ARI

Product type identification

MZSR - JK

Maximum continuous operating voltage (Uc)
200 : AC275V
400 : AC500V

-None: No gap
-AR: With gap (N-PE)

1~4: SPD connectivity number

(MZSR-400JK3ARI)
Dimensions: W72×D99×H81 (mm)
Mass: 400 (g)

Characteristics

Item	Measurement conditions	Performance													
		MZSR-200JK1	MZSR-200JK2	MZSR-200JK3	MZSR-200JK4	MZSR-200JK1 ARI	MZSR-200JK2 ARI	MZSR-200JK3 ARI	MZSR-400JK1	MZSR-400JK2	MZSR-400JK3	MZSR-400JK4	MZSR-400JK1 ARI	MZSR-400JK2 ARI	MZSR-400JK3 ARI
Item code	—	11110 42060	11110 42194	11110 42195	11110 42196	11110 28023	11110 42523	11110 42525	26098	11110 28090	11110 28092	11110 28094	11110 28091	11110 28093	11110 28095
Maximum continuous operating voltage (50Hz/60Hz) (Uc)	—	AC275V						AC500V							
Maximum discharge current (Imax)	8/20μs	40kA													
Nominal discharge current (In)	8/20μs	20kA													
Voltage protection level (Up)	Based on IEC	1.4kV or less (each phase)			1.4kV or less (each phase) 1.5kV or less (N-PE)			2.5kV or less (each phase)			2.5kV or less (each phase) 1.5kV or less (N-PE)				

Power Supply SPD IEC Class II & Class III (Type 2 & 3) Induced Lightning Countermeasures

By installing it on the boundary between LPZ1 and LPZ2 or between LPZ2 and LPZ3, this SPD has the ability to protect from induced lightning.

MZEV2-200 MZEV3-200

IEC Class II & Class III compliant

Conforming standards

- IEC 61643-11 compliant
- UL, CE marking
- RoHS II compliant

Features

- A compact, screw-fixed product that can be installed in tight spaces inside devices.
- A single SPD can offer protection between lines and earths.
- Equipped with a deterioration diagnostic function and separation mechanism.

Applications

- For protection of power supply for devices such as EV chargers.
- Assembly into a lighting board and other boards



MZEV2-200

MZEV3-200

(MZEV3-200)
Dimensions: W46×D29×H29 (mm)
(Not including cable)
Mass: 56 (g)

Characteristics

Item	Measurement conditions	Performance	
		MZEV2-200	MZEV3-200
Wiring	—	Single-phase two-wire	Single-phase three-wire, Three-phase three-wire
Rated operation voltage	—	240/120V	
Maximum continuous operating voltage (Uc)	L-L, L-PE	AC275V	
Maximum discharge current (Imax)	8/20μs	5kA (Single wire)	
Nominal discharge current (In)	8/20μs	2.5kA (Single wire)	
Voltage protection level (Up)	L-L, L-PE	1.5kV or less	
Deterioration display	—	Normal times: On / Abnormal times: Off	

Wiring terminal identification

Wiring symbol	Wiring color	Wire size/length
L1	Red	AWG14 / about 250mm
L2	Black	
L3	Blue	
PE	Yellow/Green	

External view

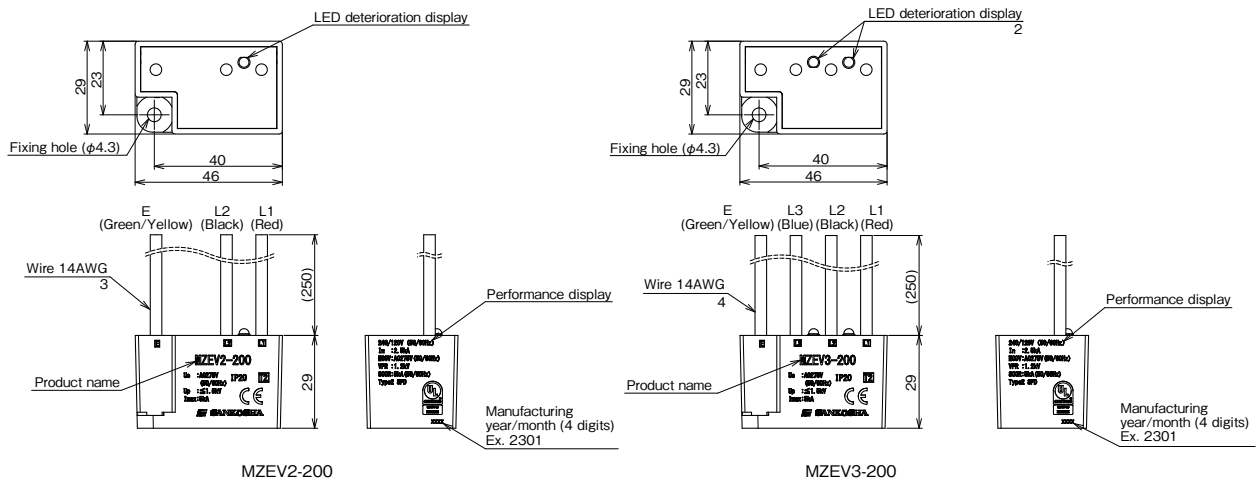

BF3-100-20kA-A BF3-200-20kA-A BF3-100/200-20kA-B HK1551, FDS-20kA-NB, HC-15

SPD external separator IEC Class II fuse

Features

- Fuse blow detection/display section replacement function
- Fuse blow display function
- Plug-in type
- DIN rail mountable (35mm)
- Contact output function (type: -A type only)
- Use FDS-20kA-SB (BF3 series only)
- By using SANKOSHA's SPD SMBP-MZSR, current breaking can be achieved in all zones when SPD shorting failure occurs.
- Registered design product

Applications

- Fuse and holders used in combination with an SPD suitable for IEC 61643-11:2011 Class II testing



BF3-200-20kA-A
(BF3-200-20kA-A)
Dimensions: W54×D139×H78 (mm)
Mass: 500 (g)



HK1551, FDS-20kA-NB, HC-15
Dimensions: W25×D80×H60 (mm)
Mass: 100 (g)

Characteristics

Item	Measurement conditions	Performance					
		BF3-100-20kA-A	BF3-200-20kA-A	BF3-100/200-20kA-B	HK1551	FDS-20kA-NB	HC-15
Item code	—	1111042005	1111042007	1111042008	1112005004	1112005003	1112005005
Rated voltage	—	AC100V	AC200V	For AC100V/200V			
Rated current	—	30A					
Alarm terminal	—	Yes			None		
Applicable power circuit	—	Single-phase three-wire AC100V	Three-phase three-wire AC200V	Single-phase three-wire AC100V (BF3-100) Three-phase three-wire AC200V (BF3-200)	Single-phase two-wire, three-wire Three-phase three-wire, four-wire		
Maximum permissible voltage	—	AC125V	AC250V				
Impulse current resistance	8/20μs	20kA·17 times					
Rated breaking capacity	—	AC250V·10kA			AC250V·100kA AC440V·10kA DC125V·1.5kA		
Temperature of use	—	-30°C~70°C				-40°C~70°C	

Installation examples

MZS-200AV+MZS-NPE

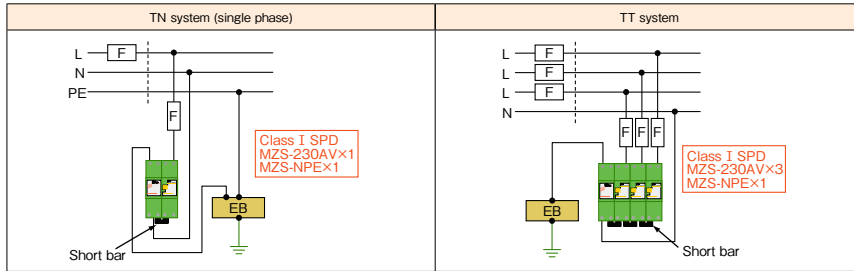

SMBP-MZSR200

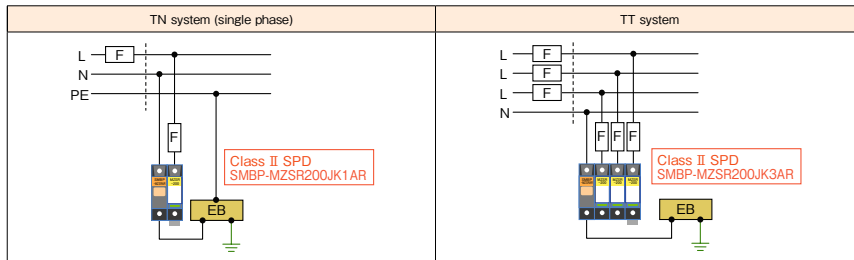

SMBP-MZSR400

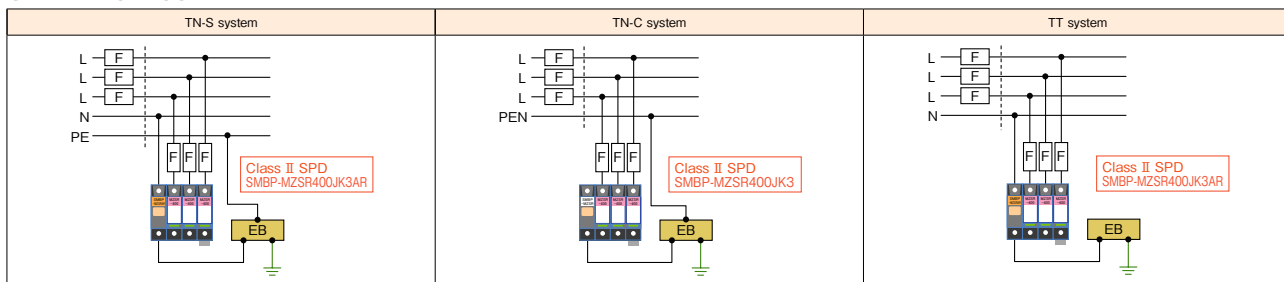

MZSR-200

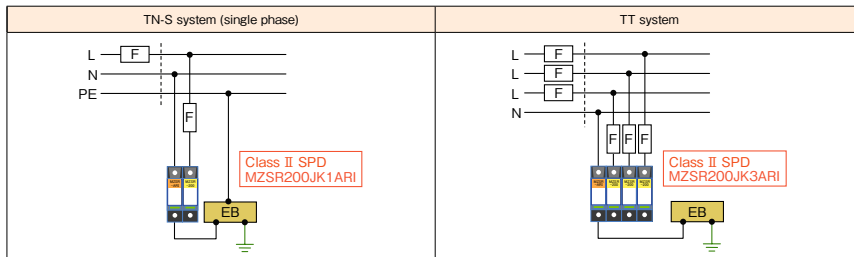

MZSR-400

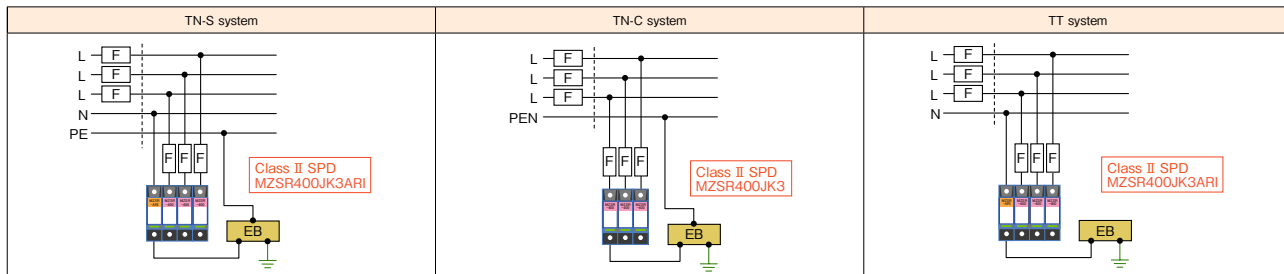

MZEV2-200, MZEV3-200

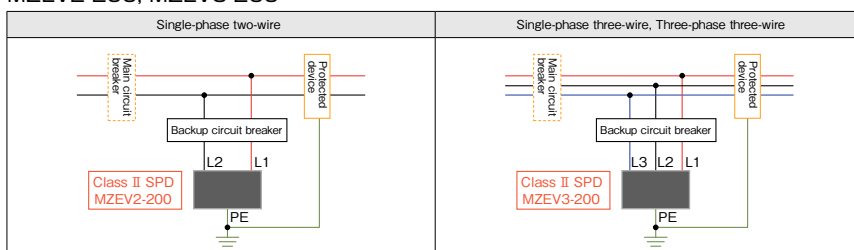

SPD for Communication Equipment

This SPD protects devices from lightning surges infiltrating from communication lines. It is compatible with IEC Category C2/D1.

Smart SPD® SMH-CLP series SMU-CLP-ALMJK

IEC Category C2/D1 compliant

Conforming standards

- IEC 61643-21 compliant
- IEC Category C2/D1 compliant
- RoHS compliant

Features

- SPD deterioration display
- Lightning surge current measurement
- Remote monitoring with contact output
- Recognition of line type by label color
- Capable to choose driving power source (external power (DC24V) or battery)
- Capable to connect 2 crimped terminals to one wiring terminal
- Capable to connect earth with both earthing terminal or DIN rail (35mm)
- Capable to install both DIN rail (35mm) or wooden board



Dimensions: W22×D115.5×H77.5 (mm)
Mass: 120 (g)

External view

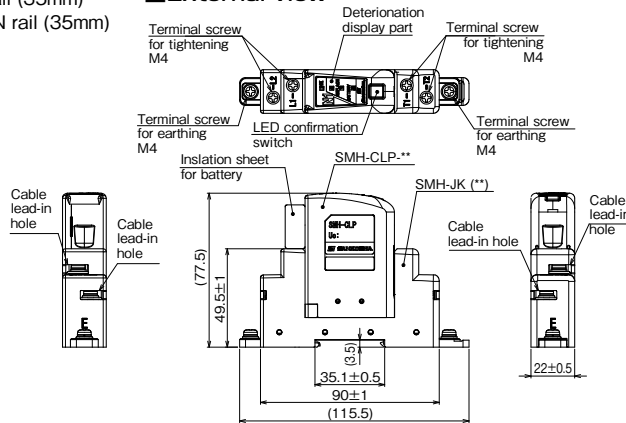

Operation

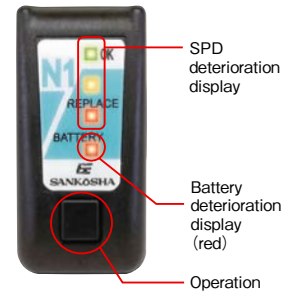

Operation		Display	State
External power	Battery	Green	Normal
Alltime lighting	Press button one-time	Yellow	Replacement recommendation
		Red	Replacement
Press button twice	Blink	Surge operation count number red: Hundreds digit Yellow: Tens digit Green: Ones digit	

Connection plug (Accessory)

Need to use connection plug to each jack when installing contact monitoring unit.



Applications/Characteristics

Item	Characteristics				
	SMU-CLP-ALMJK	SMH-CLP-N1JK	SMH-CLP-NMJK	SMH-CLP-K2JK	SMH-CLP-H3 6VJK
Item code	1111042446	1111042415	1111042418	1111042421	1111042424
Application	Contact output, external power input	Balanced circuit, wind speed meter, pyranometer, rain gauge, hygrometer	Multi-core measurement line, disaster prevention monitoring board (multi-care), wind speed meter, platinum thermometer	AC/DC 110V control circuit, relay circuit, speaker line	Instrumentation line, potentiometer, slow pulse, DC4-20mA, RS232C, RS422, RS485
Maximum continuous operating voltage (Uc)	—	DC52V		DC180V, AC140V	DC9V
Rated current	—	DC3A	—	DC3A	DC100mA
Series resistance	—	100mΩ or less	—	100mΩ or less	5Ω±10%
Insertion loss	—	1.0dB or less (DC~5MHz)		1.0dB or less (DC~10MHz)	1dB or less (DC~500kHz)
Voltage protection level (Up) (1.2/50μs, 10kV)	—	500V or less		800V or less	80V or less
Impulse durability (two lines together)	Category C2 (8/20μs)	10kA (10 times)			
	Category D1 (10/350μs)	1kA (2 times)			2.5kA (2 times)

Item	Characteristics				
	SMH-CLP-H3 12VJK	SMH-CLP-H3 24VJK	SMH-CLP-H3 48VJK	SMH-CLP-ENJK	SMH-CLP-DCJK
Item code	1111042427	1111042429	1111042431	1111042433	1111042443
Application	Instrumentation line, potentiometer, slow pulse, DC4-20mA, RS232C, RS422, RS485		Telephone line, ADSL		DC24V, DC48V power supply
Maximum continuous operating voltage (Uc)	DC13.5V	DC27V	DC52V	DC180V	DC52V
Rated current	DC100mA				
Series resistance	5Ω±10%			12Ω or less	100mΩ or less
Insertion loss	1dB or less (DC~1MHz)			1.0dB or less (DC~10MHz)	1.0dB or less (DC~500kHz)
Voltage protection level (Up) (1.2/50μs, 10kV)	100V or less	120V or less	140V or less	400V or less	500V or less
Impulse durability (two lines together)	Category C2 (8/20μs)	10kA (10 times)			
	Category D1 (10/350μs)	2.5kA (2 times)			

Category	Recommended connection line cross-sectional area (Protected device-SPD L terminal)	Recommended grounding line cross-sectional area (SPD terminal- Protected device)
D1	1.25mm ² or Existing wiring diameter	1.25mm ²
C2	1.25mm ² or Existing wiring diameter	1.25mm ²

IEC 62305-4:2010

ZP series

IEC Category C2/D1 compliant

Conforming standards

- IEC 61643-21 compliant
- RoHS compliant

Features

- Slim design enables space saving
- Plug-in type (circuit not broken by inserting or removing plug)
- DIN rail mountable (35 mm)
- Special tester (ZPT1 type) can be used to detect deterioration.
- Round type crimped terminal for M4 (N type)

External view

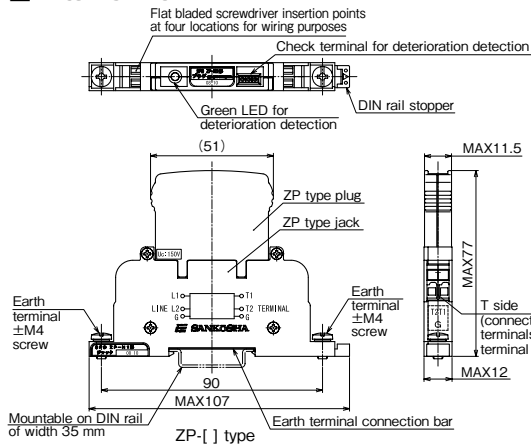

ZP [] (Regular type)
Dimensions: W12×D107×H77 (mm)
Mass: 70 (g)



ZP-[]N (Screw terminal type)
Dimensions: W17.6×D127×H77 (mm)
Mass: 70 (g)

* DC24, H2-H1, N1, NM, EN1, EN3, K2, H3 24V only

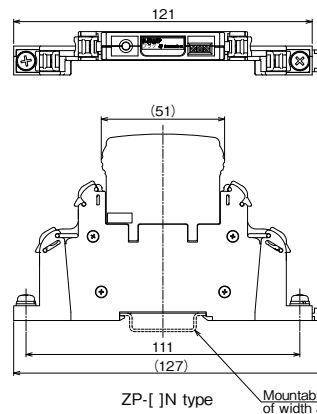

Special tester for deterioration detection ZPT1 series (Batteries sold separately)

Applications/Characteristics

Item	Performance									
	ZP-A1JK	ZP-DC24JK	ZP-DC24 JKN	ZP-DC48JK	ZP-H2-H1JK	ZP-H2-H1 JKN	ZP-N1JK	ZP-N1 JKN	ZP-NMJK	ZP-NM JKN
Item code	1111020962	1111021886	1111042087	1111021889	1111021407	1111042316	1111018165	1111023552	1111013225	1111023555
Applications	Telephone line, ISDN line, ADSL line, xDSL line	DC 24V signal line, control circuit		DC 48V signal line, control circuit	RS422, RS485		Balanced circuit, wind speed meter, pyranometer, rain gauge, hygrometer		Multi-core measurement line, disaster prevention monitoring board (multi-core), wind speed meter, platinum thermometer	
Maximum continuous operating voltage (Uc)	DC170V	DC27V		DC52V	DC5V		DC150V			
Rated current	DC100mA	DC3A			DC100mA		DC3A		—	
Series resistance	10Ω or less	—			5Ω±10%		—		—	
Voltage protection level (Up)	1.0kV or less	500V or less			50V or less		1.0 kV or less (to ground) 50V or less (inter line) * In case of balanced circuit	1.0 kV or less (to ground) 50V or less (inter line)		
Impulse durability (two lines together)	Category C2 (8/20 μs)	10kA (10 times)			10kA (10 times)		4kA (10 times)			
	Category D1 (10/350 μs)	2.5kA (2 times)			2.5kA (2 times)		1kA (2 times)			
Wiring method	Relay wiring (○), Suspended wiring (×)	Relay wiring (○), Suspended wiring (○)			Relay wiring (○), Suspended wiring (×)		Relay wiring (○), Suspended wiring (○)	Relay wiring (×), Suspended wiring (○)		

Item	Performance											
	ZP-EN1JK	ZP-EN1 JKN	ZP-EN3JK	ZP-EN3 JKN	ZP-K2JK	ZP-K2 JKN	ZP-H3 06VJK	ZP-H3 12VJK	ZP-H3 24VJK	ZP-H3 24VJKN	ZP-H3 48VJK	
Item code	1111012089	1111023556	1111012095	1111023553	1111012263	1111023551	1111012084	1111012092	1111012101	1111023554	1111012098	
Applications	Telephone line, ADSL, EPBX, xDSL		ISDN, xDSL, digital leased line		AC/DC 110V control circuit, relay circuit, speaker line		Instrumentation line, potentiometer, slow pulse, DC 4-20mA, RS232C, RS422, RS485					
Maximum continuous operating voltage (Uc)	DC170V		DC52V		DC180V, AC140V		DC9V	DC13.5V	DC27V		DC52V	
Rated current	DC100mA				DC3A		DC400mA	DC100mA				
Series resistance	10Ω or less				—		5Ω±10%					
Voltage protection level (Up)	400V or less	200V or less			800V or less		80V or less	100V or less	120V or less	140V or less		
Impulse durability (two lines together)	Category C2 (8/20 μs)	10kA (10 times)				4kA (10 times)		10kA (10 times)				
	Category D1 (10/350 μs)	2.5kA (2 times)				1kA (2 times)		2.5kA (2 times)				
Wiring method	Relay wiring (○), Suspended wiring (×)				Relay wiring (○), Suspended wiring (○)		Relay wiring (○), Suspended wiring (×)					

* Applicable wires: 0.08 to 2.5 mm²

SPD for Communication Equipment

This SPD protects devices from lightning surges infiltrating from communication lines. It is compatible with IEC Category C2/D1.

HOWL2 SMB-P-R series

IEC Category C2/D1 compliant

Conforming standards

- IEC 61643-21 compliant
- IEC category C2/D1 compliant
- RoHS compliant

Features

- Applicant up to 10 core wiring
- LED deterioration display function
- Replacement recommendation display function
- Lightning surge count display function
- DIN rail (35mm) mounting
- Design registered product

Part name

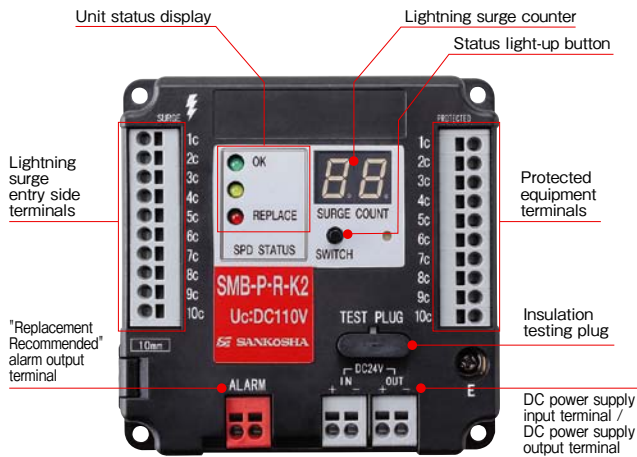

SMB-P-R-NM

SMB-P-R-NM(H)

SMB-P-R-K2



SMB-P-R-H3

SMB-P-R-485

Dimensions: W100×D31×H100 (mm)
Mass: about 200 (g)

External view

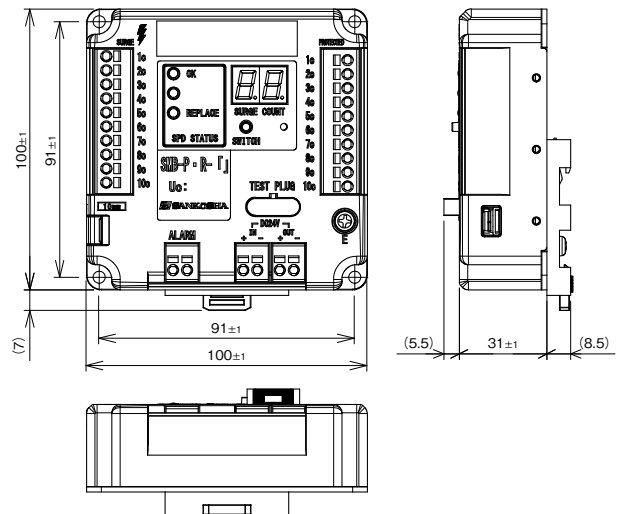

Innovative status display

LEDs make the SPD status easier to read. "Replacement Recommended" function helps you make a replacement before a malfunction occurs.

<LED display>

- Green: OK
 - Yellow: Replacement recommended
 - Red: Replace
- When replacement is recommended, the alarm terminal outputs an alarm signal.



Visualization of lightning surges

When a lightning surge comes in, a 7-segment display shows the number of times the unit has operated.

Applications/Characteristics

Item	Characteristics					
	SMB-P-R-NM	SMB-P-R-NM (H)	SMB-P-R-K2	SMB-P-R-H3	SMB-P-R-485	
Item code	1111042134	1111042137	1111042138	1111042135	1111042136	
Application	Alarm transfer line, sensor line	Alarm transfer line, sensor line, high durability type for impulse current	Bell + Display light	Instrumentation line (DC4-20mA etc.)	RS485 + Maintenance telephone	
Maximum continuous operating voltage (Uc)	DC48V	DC48V	DC110V	27V	RS485 DC15V	Maintenance telephone DC48V
Rated current	1A		3A	100mA	1A	
Series resistance	1Ω or less			4Ω~6Ω	1Ω or less	
Impulse current durability	8/20μs	5kA	10kA	5kA		
	10/350μs	2.5kA				
Voltage protection level (Up)	1.2/50μs, 10kV	500V or less	500V or less	1kV or less	150V or less	100V or less 500V or less
Connection core	10 cores				8 cores	2 cores

Category	Recommended connection line cross-sectional area (Protected device-SPD L terminal)	Recommended grounding line cross-sectional area (SPD terminal- Protected device)
D1	1.25mm ² or Existing wiring diameter	1.25mm ²
C2	1.25mm ² or Existing wiring diameter	1.25mm ²

IEC 62305-4:2010

Smart SPD® SMB-KRAPS1

SPD for Krone LSA-plus terminal
IEC Category C2/D1 compliant

Conforming standards

- IEC 61643-21 compliant
- RoHS compliant

Features

- Replacement recommendation display function
- Lightning surge count display function

Applications

- Communication line (MDF/IDF)



Smart SPD®
SMB-KRAPS1

Dimensions: W9.1×D22×H75 (mm)
Mass: 8 (g)

External view

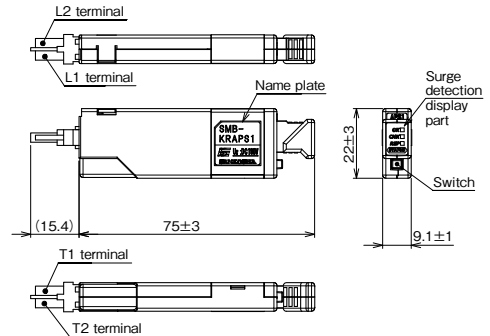

Operation

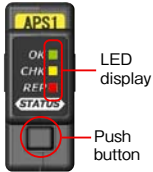

Operation	Display	State
Press button onetime	Green	Normal
	Yellow	Replacement is recommended in multi lightning area.
	Red	Replacement is recommended.
	All	Deterioration. Replacement.
Press button twice	Blink	Surge count number (Red: Hundreds digit, Yellow: Tens digit, Green: Ones digit)

Surge detection part's performance

Item	Specification	Remarks
Minimum surge detection sended current	±20A or more	8/20μs
Maximum surge permissible current	±10kA (one line ±5kAx2)	8/20μs
Display	Green LED Yellow LED Red LED	·Replacement recommendation level display ·SPD deterioration display ·Count number display ·Battery replacement display
Operation	Button switch	·Onetime/twice pressing
Power supply	Button battery (CR1220) Battery lifetime more than 5 years*	Able to replace battery

*Can be changed by operating condition and operation.

KR-APS1

SPD for KRONE terminal
IEC Category C2/D1 compliant

Conforming standards

- IEC 61643-21 compliant
- RoHS compliant



KR-APS1

Dimensions: W9.1×D22.2×H74.5 (59) (mm)
Mass: 10 (g)

* Dimensions in parentheses () represent height when mounted on Krone module

External view

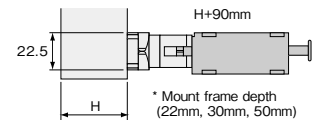

SPD installation diagram

[When using mount frame]

[When using profile frame]

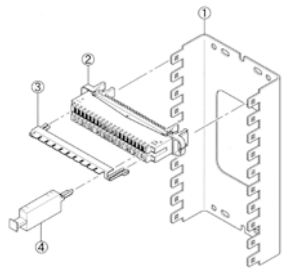

- Mount frame
- LSA-PLUS switching terminal
- Earth bar
- SPD

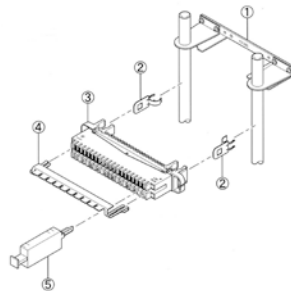

- Profile set
- Earth clip
- LSA-PLUS switching terminal
- Earth bar
- SPD

Applications/Main performance characteristics (SMB-KRAPS1 · KR-APS1)

Item	Performance	
	SMB-KRAPS1	KR-APS1
Item code	1111027491	1111022825
Application	ADSL, TEL, ISDN	
Maximum continuous operating voltage (Uc)	DC180V	
Rated current	DC100mA	
Series resistance/wire	10Ω or less	10Ω
Insertion loss	DC~5MHz 1.0dB or less	
Voltage protection level (Up)	1.2/50μs ·10kV	500V or less
Impulse durability*1	Category C2 (8/20μs)	10kA (10 times)
	Category D1 (10/350μs)	2.5kA (2 times)
Deterioration display*2	Yes	Yes (■ : normal; ■ : deteriorating)

*1 Impulse durability :Category C2 is 2 line total value. Category D1 is 1 line value.

*2 APS1 are also available without the deterioration display function.

SPD for Co-axial Connectors

This is used for protecting communication devices that use co-axial lines and high-frequency bandwidth from lightning surges.

CX-E-60 CX-E-60(R)

IEC Category C2/D1 compliant

Conforming standards

- IEC 61643-21 compliant
- RoHS compliant

Features

- Optimized design for coaxial LAN converter
- PoE power supply function to cameras etc enabled
- Low insertion loss less than 1.0dB in DC to 50MHz
- Insulation type BNC connector

Applications

- Coaxial LAN converters
- Monitoring cameras (power source superimposed)
- Data transmission devices



Dimensions: W38×D95×H40 (mm)
Mass: 130 (g)

External view

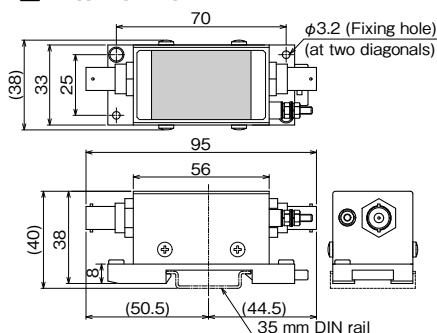

Characteristics

Item	Performance	
	CX-E-60	CX-E-60(R)
Item code	1111042385	1111050117
Connector type	BNC (J-J)	
Frequency bandwidth	DC~50MHz	
Insertion loss	1.0dB or less	
Maximum continuous operating voltage	DC70V	
Impedance	50Ω/75Ω	
Rated current	1A	
Voltage protection level	1.2/50μs, 10kV	250V or less (between conductors) 500V or less (to ground)
Impulse durability	Category C2 (8/20μs)	10kA (10 times)
	Category D1 (10/350μs)	2kA (2 times)
Series resistance	1Ω±20%	



Dedicated tester for judging deterioration "ZP-T1" (Battery sold separately)

GPSP1-L1-TNCJJ GPSP1-L1-NJJ GPSP2-L1-NJJI

IEC Category C2 compliant

Conforming standards

- IEC 61643-21 compliant
- RoHS compliant

Features

- The lineup includes insulated types and discharge types.
- Also compatible with DC supply to antennas
- At low-loss GPS L1 bands:
LOSS: 1.0dB or less VSWR: 1.3 or less

[Discharge type]

- Voltage protection level of 10V or less
- Connector shape can be selected from the TNC type or N type

[Insulated type]

- Equipped with DC output indicator for visually checking operating conditions.

Applications

- GPS antenna port

[Discharge type]



GPSP1-L1-TNCJJ GPSP1-L1-NJJ
Dimensions: W94×D89×H26.9 (mm)
Mass: 220 (g)

[Isolation type]



GPSP2-L1-NJJI
Dimensions: W145.4×D200×H44 (mm)
Mass: 1100 (g)

External view

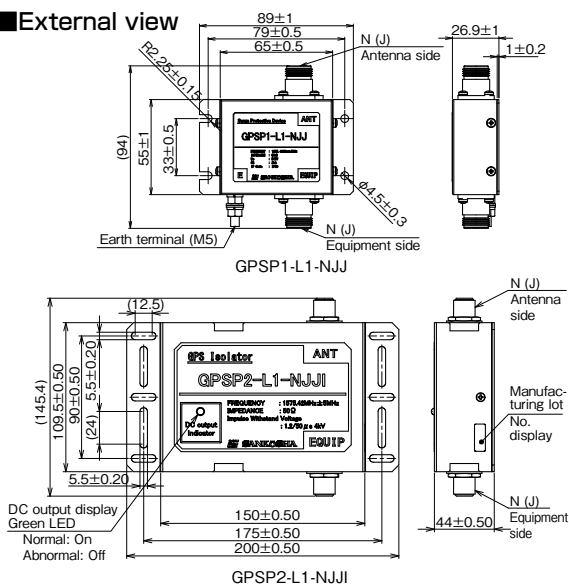

Characteristics

Item	Performance		
	GPSP1-L1-TNCJJ	GPSP1-L1-NJJ	GPSP2-L1-NJJI
Item code	1111042265	1111042266	1111042555
Protection system	Discharge type		Isolation type
Connector type	TNC (J-J)	N (J-J)	N (J-J)
Frequency bandwidth	1575.42MHz ± 5MHz		
V.S.W.R	1.3 or less		
Insertion loss	1.0dB or less	0.3dB or less	
Impedance	50Ω		
Permissible power	10W		
Voltage protection level	10V or less		—
Impulse durability	Category C2 8/20μs	2kA (10 times)	
Impulse withstand voltage	1.2/50μs	—	4kV or more

Installation examples

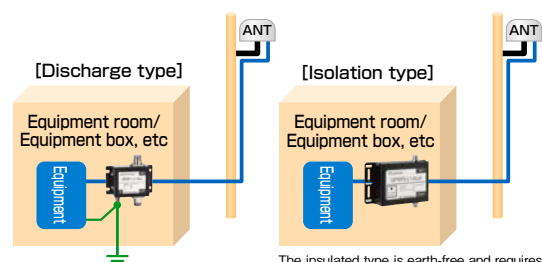

The insulated type is earth-free and requires no grounding work.

N-JP-1S
N-JP-5 (permissible power 60W)
N-JP-2260ST
N-JP-8 (permissible power 200W)

- IEC Category C2/D1 compliant**
- Conforming standards**
- IEC 61643-21 compliant
 - RoHS compliant
 - RoHSII compliant (N-JP-2260ST)



N-JP-1S · N-JP-5
 Dimensions: W20.8×D50×H24.3 (mm)
 Mass: 80 (g)



N-JP-2260ST
 Dimensions: W21×D50.2×H35.9 (mm)
 Mass: 100 (g)



N-JP-8
 Dimensions: W20×D61.2×H27.3 (mm)
 Mass: 106 (g)

External view

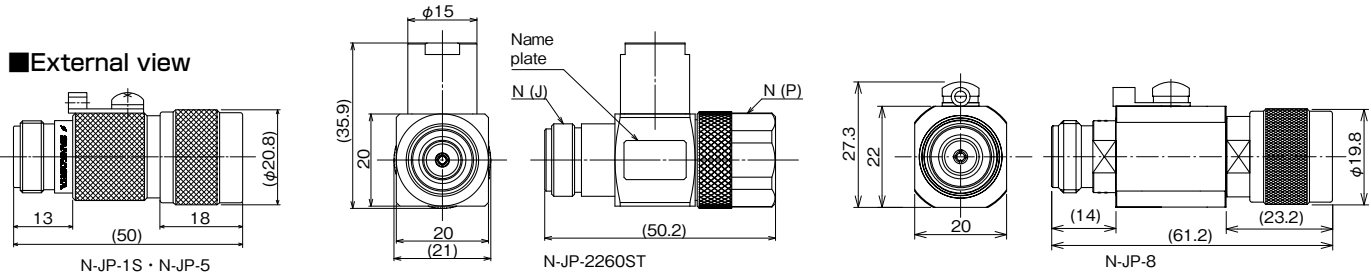

Characteristics

Item	Performance			
	N-JP-1S	N-JP-5	N-JP-2260ST	N-JP-8
Item code	1112003509	1112004585	1111050073	1111020914
Applications	Wireless communication devices, Measuring instruments		5G fifth generation mobile communication system, Local 5G (Sub6 band), Wireless communication devices, ITS (high-speed road traffic system), Wireless LAN 2.4GHz band, 5GHz band	Wireless communication devices, Measuring instruments
Connector type	N type (P-J)			
Frequency bandwidth	DC to 3GHz		2.2GHz to 6.0GHz (DC superimposition not possible)	DC to 2.2GHz
V.S.W.R	1.2 or less		1.35 or less	1.2 or less
Insertion loss	0.2dB or less	0.3dB or less	0.2dB or less	0.2dB or less
Impedance	50Ω			
Permissible power	10W	60W	Max 100W	Rating: 100W/Max: 200W
Voltage protection level	700V or less (1kV/μs) 900V or less (1.2/50μs 10kV)		20V or less (1.2/50μs, 10kV / 10/200μs, 10kV)	1.1kV or less 1.2/50μs (Open circuit voltage), 8/20μs, 5kA (Short circuit voltage)
DC sparkover voltage	DC120V or more	DC200V or more	—	DC400 to 600V
Impulse durability	Category C2 (8/20μs)	5kA (10 times)	30kA (10 times)	20kA (10 times)
	Category D1 (10/350μs)	2.5kA (2 times)	1kA (2 times)	2.5kA (2 times)

F-JP-1W
F-JJ-1W

- IEC Category C2/D1 compliant**
- Conforming standards**
- IEC 61643-21 compliant
 - RoHS compliant
- Applications**
- 4K, 8K, CS, BS, TV tuners



F-JP-1W
 Dimensions: W19.8×D56.6×H25.1 (mm)
 Mass: 68 (g)

(F-JJ-1W / Dimensions: W19.8×D47.5×H19.8 (mm))

External view

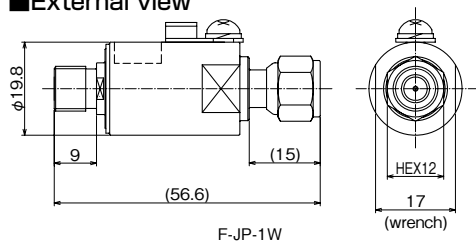

Characteristics

Item	Performance	
	F-JP-1W	F-JJ-1W
Item code	1111012197	1111012170
Connector type	F type (P-J)	F type (J-J)
Frequency bandwidth	DC to 3.3GHz*	
V.S.W.R	1.5 or less*	
Insertion loss	0.5dB or less*	
Impedance	75Ω*	
Permissible power	50W	
Voltage protection level	800V or less	
DC sparkover voltage	DC200V or more	
Impulse durability	Category C2 (8/20μs)	2kA (10 times)
	Category D1 (10/350μs)	1kA (2 times)

* Characteristics when exceeding 3.0GHz are reference values.
 * For connecting a cable to an F type coaxial SPD, use an F connector with contact pin.

SPD for LAN

This product protects servers, PCs, and network devices from infiltrating lightning surges.

LAN-CAT6A-P+II(R) (Discharge type)

IEC category C2/D1 compliant

Conforming standards

- IEC 61643-21 compliant
- RoHSII compliant
- UL standard aquired (E140906)

Features

- Compatible with 10 Gigabit Ethernet and Multi Gigabit Ethernet
- Compatible with PoE++ (IEEE802.3bt)
- Equipped with deterioration diagnosis function
- Also compatible with UTP cable and STP cable (shield cable)
- Also protects against abnormal voltage on shield parts
- DIN rail mountable (35mm)
- Collective grounding is possible by attaching to conductive DIN rail

Applications

- 10 Gigabit Ethernet
- Network cameras
- Wireless LAN access points
- Outdoor installed network devices



LAN-CAT6A-P+II (R)
Dimensions: W22×D89×H35 (mm)
Mass: 60 (g)



When using dedicated tester

LAN-CAT6A-IS (Isolation type)

Earth-free type not requiring earthing construction work or protecting equipment without earthing connectors

Conforming standards

- IEC 61643-351 compliant
- RoHSII compliant
- UL standard aquired (E532596)

Features

- Uses an insulated circuit
- Compatible with 10 Gigabit Ethernet and Multi Gigabit Ethernet
- Impulse withstand voltage 6kV or higher
- Also compatible with UTP cable and STP cable (shield cable)
- DIN rail mountable (35mm)

Applications

- 10 Gigabit Ethernet
- Network cameras
- Wireless LAN access points
- Outdoor installed network devices



LAN-CAT6AS-IS
Dimensions: W22×D89×H35 (mm)
Mass: about 45 (g)

LAN-1000IS-2 (Isolation type)

Earth-free type not requiring earthing construction work or protecting equipment without earthing connectors

Conforming standards

- IEC 61643-351 compliant
- RoHS compliant

Features

- Uses isolation type circuits
- Gigabit Ethernet 1000BASE-T enabled
- Impulse withstand voltage 15kV or more
- DIN rail mountable (35mm)

Applications

- Gigabit Ethernet
- Network cameras
- Ordinary households (PCs, network devices)



LAN-1000IS-2
Dimensions: W22×D89×H35 (mm)
Mass: 55 (g)

External view

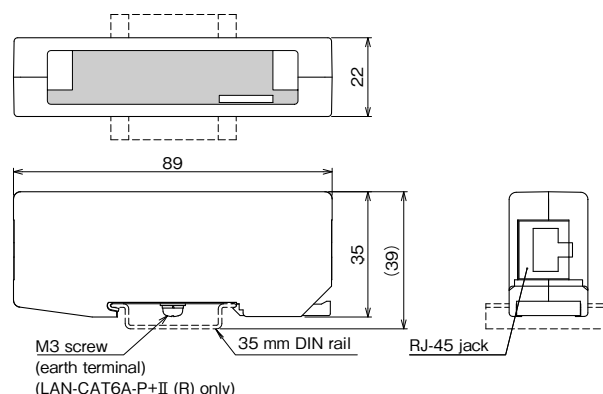

Characteristics

Item	Performance		
	LAN-CAT6A-P+II (R)	LAN-CAT6A-IS	LAN-1000IS-2
Item code	1111043516	1111050105	1111042225
Applicable lines	IEEE802.3	10BASE-T	
	IEEE802.3u	100BASE-TX	
	IEEE802.3ab	1000BASE-T	
	IEEE802.3bz		
	IEEE802.3bz	2.5GBASE-T	—
	IEEE802.3an	5GBASE-T	—
	IEEE802.3af	10GBASE-T	—
	IEEE802.3at	PoE	—
Transmission loss	1~100MHz	1.0dB or less	2.0dB or less
	~250MHz	2.0dB or less	—
	~500MHz	4.0dB or less	—
Maximum continuous operating voltage (Uc)	Between each line and earth terminal	DC60V	—
Voltage protection level (Up)	Between each line and earth terminal (1.2/50μs, 10kV)	500V or less	—
Impulse durability (Total of 8 cores)	Category C2 (8/20μs)	5kA (10 times)	—
	Category D1 (10/350μs)	2.5kA (2 times)	—
Maximum discharge current	8 core and shield-ground total value (8/20μs)	10kA (10 times)	—
AC withstand voltage	—	2.0kV or more (between primary and secondary line)	4kV or more
Impulse withstand voltage	1.2/50μs	—	6.0kV or more (between primary and secondary line)
	10/700μs	—	15kV or more

Earthing SPD (earth balancer)

This product activates to equalize potential when potential disparity arises between earths due to lightning strike.

MZS-EB MZS-EBT

Earth equipotentialization
(eliminates electropotential difference)

Conforming standards

- RoHS compliant

Features

- Corresponds to IEC Class I test
- Impulse current up to 75 kA (direct strike waveform 10/350 μs)
- DIN rail mountable (35 mm)
- Deterioration display function (warning contact output terminal attached) only MZS-EBT



MZS-EB
Dimensions: W35×D125×H66 (mm)
Mass: 300 (g)

MZS-EBT
Dimensions: W35×D125×H77 (mm)
Mass: 350 (g)

Characteristics

Item	Measurement conditions	Performance	
		MZS-EB	MZS-EBT
Item code	—	1111019226	1111042332
Impulse current (Iimp)	10/350μs	75kA	100kA
Nominal discharge current (In)	8/20μs	20kA	100kA
Insulation resistance	DC350V	1,000MΩ or more	—
	DC100V	—	100MΩ or more
Voltage protection level (Up)	Based on IEC	1.5kV or less	

External view (MZS-EB)

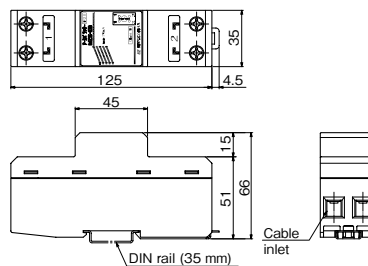

Circuit diagram

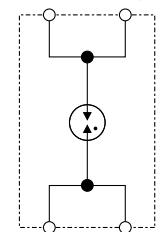

Earth Grounding Materials

Comprising mainly special carbon particles and cement, this grounding product causes no pollution.

SAN-EARTH (M5C) Confirming Standard IEC62561-7:2018

SAN-EARTH (M5C) absorbs the moisture in the surrounding soil and hardens naturally, making it ideal for installation in locations where it would be difficult to transport water. Examples of how SAN-EARTH (M5C) is used in construction work are shown below.

Basic construction method

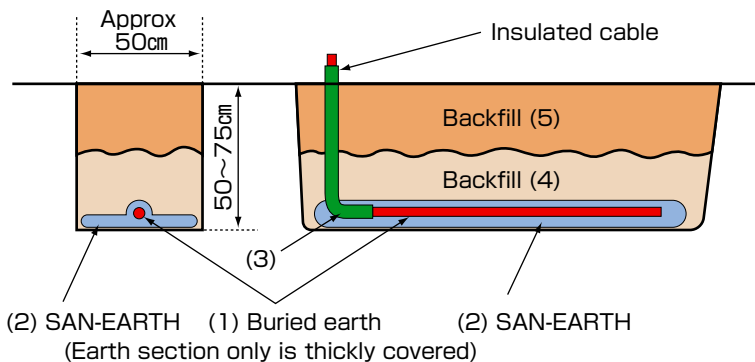

- (1) Lay earth wires.
- (2) Scatter SAN-EARTH so that the earth wires are completely covered.
(Thickly around the earth wires, thinly at other locations)
- (3) About 30cm of the covered part of the rising section of the earth wire is also embedded in SAN-EARTH.
- (4) Carefully backfill with soil to a depth of around 10cm and tread down to compact it.
- (5) Completely backfill with soil.

Note: If the earth wires are not completely covered with SAN-EARTH, they may corrode due to electropotential difference and the effect of electrolytic corrosion prevention will be lost.

Example of laying SAN-EARTH M5C



Laying SAN-EARTH M5C *One 25kg bag of M5C will cover approx. 3 meters (width 50cm) .

SANKOSHA proposes industry-leading lightning protection solutions.
Don't hesitate to talk to us.



SANKOSHA Corporation: 2-11-1 Osaki, Shinagawa-ku, Tokyo 141-0032, Japan

English: <https://www.sankosha.co.th/>

Chinese: <https://www.sankosha.co.th/hk/>

Thai: <https://www.sankosha.co.th/th/>

Vietnamese: <https://sankosha.vn/>

Korean: <https://www.sankosha.kr/>

Japanese: <https://www.sankosha.co.jp/>

- For printing reasons, the colors shown in the catalog may differ from those of the actual products.
- Thank you in advance for understanding that product specifications and external appearance may sometimes undergo slight changes for the sake of improvement.

The content of this catalog is correct as of October 2023.

AD-141/23.10